

45mm ELITE ROLLER MECHANISM 401519

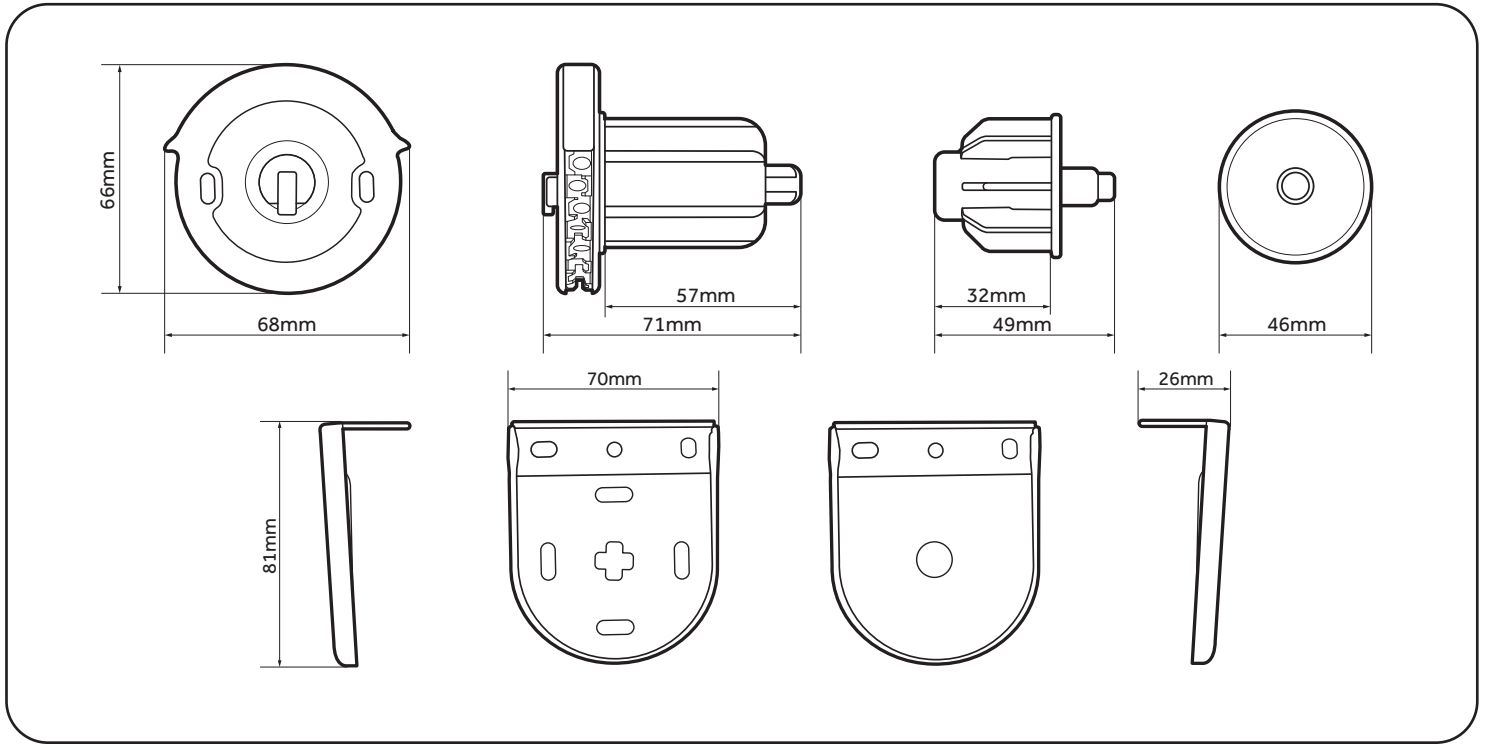

FITTING A CHAIN

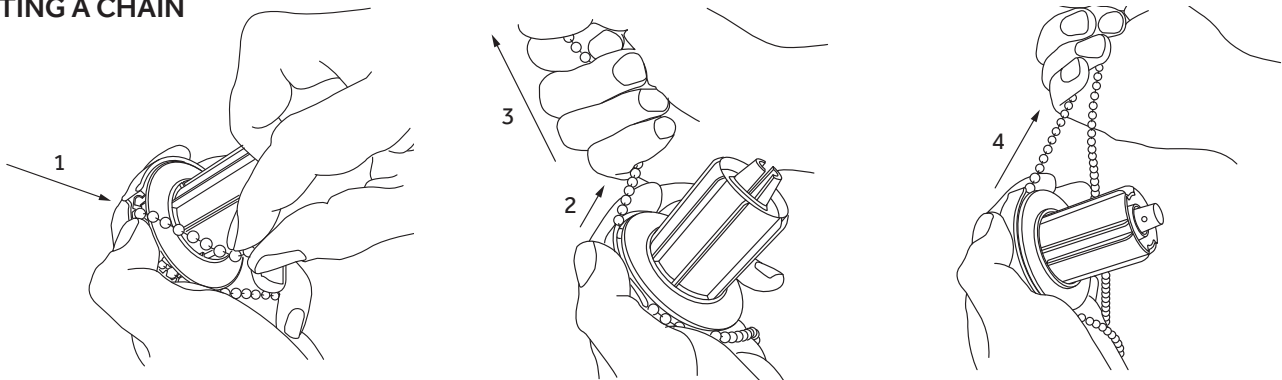

FITTING MECHANISM INTO A TUBE

