

INTU Micro Bead Fit Installation Instructions

Exploded Diagram

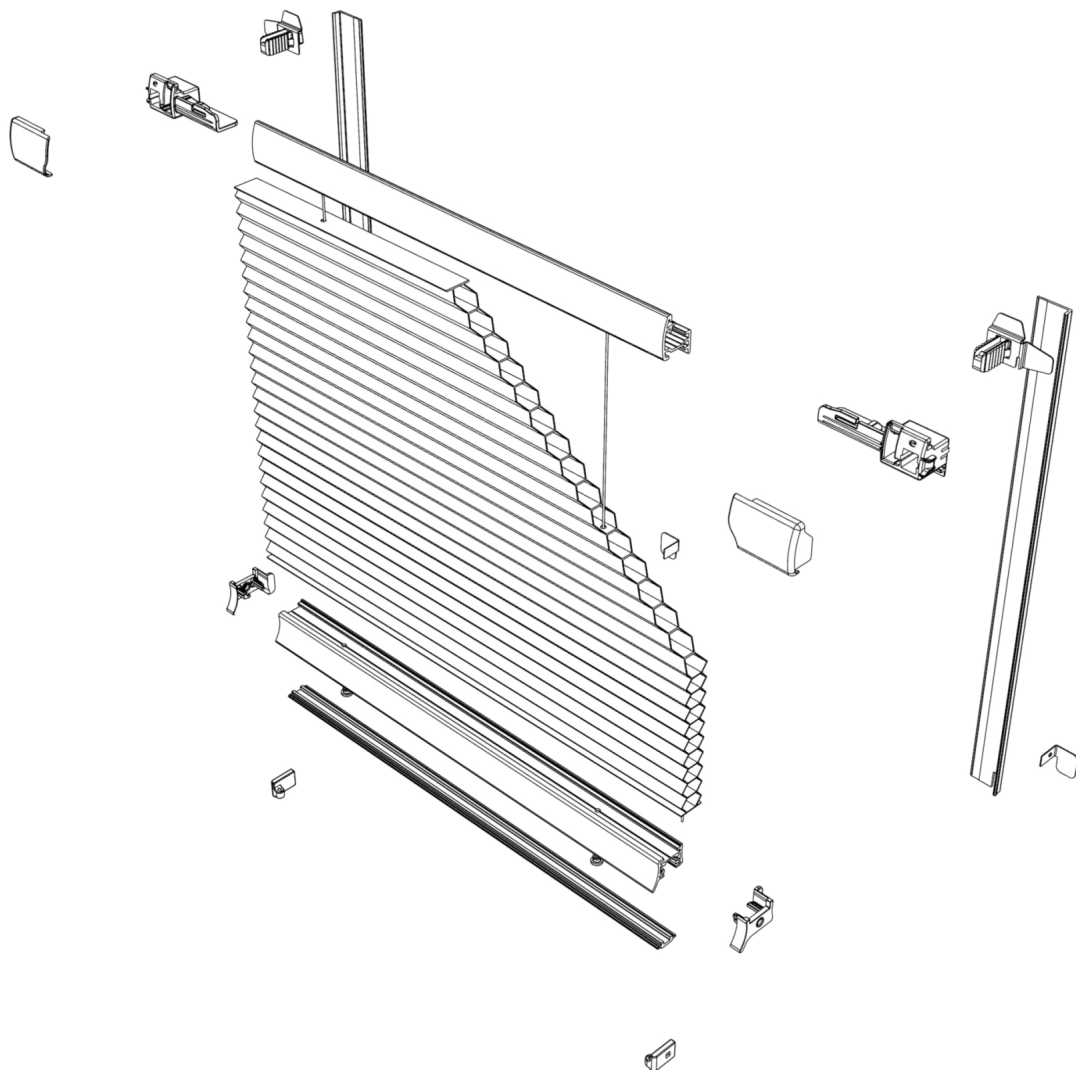

You will need:

- INTU Fitting Tool
- INTU Top Corner Brackets
- INTU Bottom Corner Brackets
- INTU Retention Clips

Note: The above should be supplied with your blind.

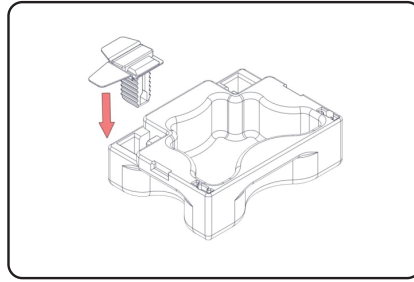

1. Place the top corner bracket into the slot on the fitting tool.

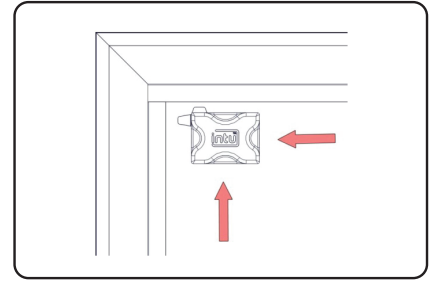

2. Position bracket behind the rubber bead and carefully push until the metal legs are behind the rubber bead. Check bracket is square to the sides of the bead and it is secure. Repeat for other side.

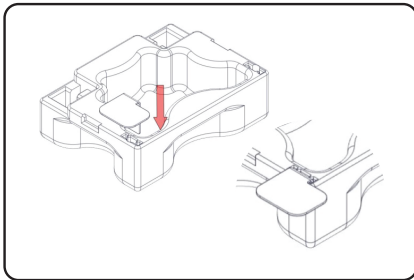

3. Place the bottom corner bracket into the slot on the fitting tool.

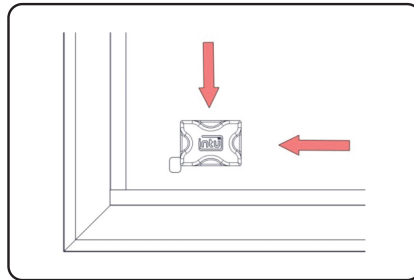

4. Position bracket behind the rubber bead and push until the metal leg is behind the bead. Check bracket is parallel to bead and is securely fitted. Repeat for the other side.

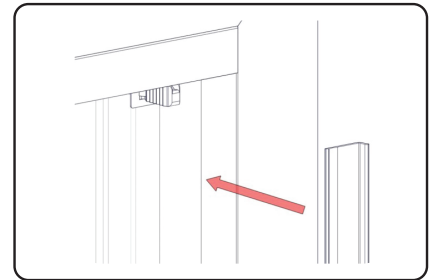

5. Place the flat side of the side extrusion against the glass with the notch to the bottom.

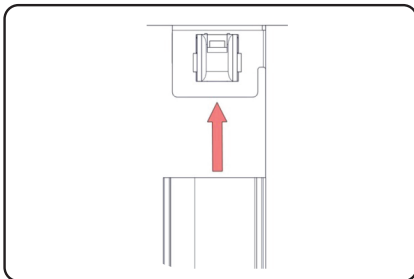

6. Slide the side extrusion up until its slots into the top corner fixing bracket. The side extrusion should rest under the bracket. Push the slot at the base of the extrusion over the bottom corner bracket. Repeat for both sides.

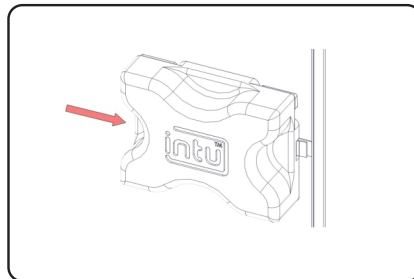

7. At the appropriate position(s) on each side profile, fit retention clips (long side profiles only). Press into position using the fitting tool.

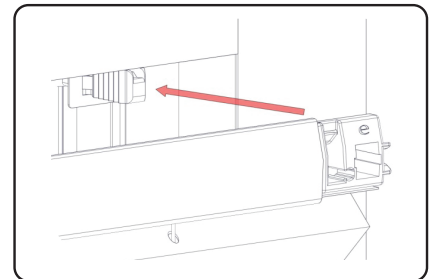

8. Align headrail endcaps with top corner fixing brackets and push fully home.

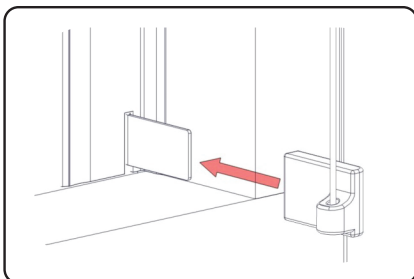

9. Align bottom button with bottom corner brackets. Slide the bottom button onto the bracket until it locates. Repeat both sides.

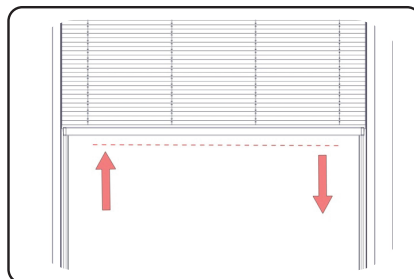

10. To align the bottom rail horizontally, simply pull it into the position desired. It will stay in position under tension from the cords.

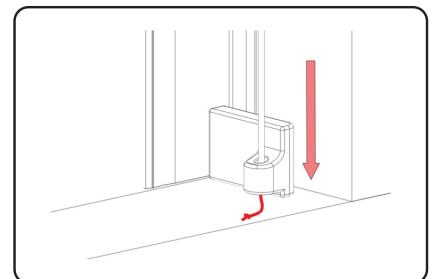

11. If your blind requires further tension pull the cord through the hole in bottom button until you feel the blind has sufficient tension and tie a fresh knot.